



Dealer stamp

Ocean Signal Ltd  
info@oceansignal.com  
www.oceansignal.com



# Survival Solutions

Whilst every effort has been made to ensure the information in this brochure is accurate, products and specifications may be changed without notice.





Ocean Signal's rescueME range of safety products provides both recreational and commercial mariners with simple to use, compact and affordable life-saving solutions.

rescueME is derived from Ocean Signal's extensive experience in developing world class products for the professional GMDSS and SOLAS deep sea sector (the SafeSea range).

With one of the most experienced research and development teams in marine communications, Ocean Signal has built a reputation for bringing an innovative and ground-breaking approach to its products, ensuring exceptional performance and reliability.

rescueME safety products offer life-saving communication solutions regardless of your activity or location. Whether sailing on inshore waters or conquering the high seas, trekking alone or as part of an expedition, or working in remote regions, you will find a product for you. rescueME offers you peace of mind and rapid deployment of appropriate assistance should you find yourself in a life threatening situation.

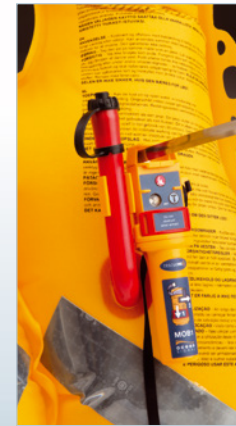

Being at the forefront of technology enables Ocean Signal engineers to design products that are both small in size and provide long operational life. Products are not only competitively priced, but the overall cost of ownership is kept low by ensuring exceptional time between battery change or product replacement.

Making sure you choose the right product to meet your activity and location is essential. In the back of this brochure is a product selection guide which will assist you in making the most appropriate choice of product.







rescueME EPIRB1 the world's most compact Emergency Position Indicating Radio Beacon.\*

-  30% (typ) smaller
-  10 year battery life
-  5 year warranty†
-  66 channel GPS  
– Fast accurate positioning
-  Retractable antenna
-  Manual release bracket
-  Auto activation  
Not available in Australia and New Zealand
-  Class 3 approved  
Australia and New Zealand

In an emergency rescueME EPIRB1 provides 3 methods of communicating your location, ensuring maximum chance of survival.

-  **406 MHz**  
406MHz  
Link via satellite to Emergency Services
-  **121.5 MHz**  
121.5MHz  
Homing Beacon to aid location by Search & Rescue
-  High intensity strobes



The rescueME EPIRB1 provides peace of mind with an impressive 10 year battery life. The world's most compact EPIRB can always be on hand, as its small size allows it to be easily retained within its manual release bracket or placed in an emergency grab-bag or life raft.

A simple protective tab over the operating keys prevents inadvertent activation yet allows for easy single handed activation when required.

The rescueME EPIRB1 also features two high brightness strobes to maximise visibility in low light conditions. The retractable antenna provides maximum protection and a reduced outline for stowage. When required the antenna is easily deployed with a gentle pull.

An EPIRB is the essential safety product for your boat. You should never consider leaving port without one! The rescueME EPIRB1 is supplied with an integrated 66 channel GPS as standard, providing accurate positional information to the emergency services to assist rapid rescue.

When activated, the rescueME EPIRB1 transmits your position and your unique ID to a Rescue Coordination Centre via satellite link. This information is then forwarded to the relevant local Search and Rescue services (see diagram).



Single handed activation



Protective tab

\*When operating offshore or long distance voyages, the Ocean Signal EPIRB E100G offers an exceptional 96 hour operational life with the option of an automatic release housing (mandatory for vessels approved under SOLAS regulations).

For more information visit [www.oceansignal.com](http://www.oceansignal.com)





\*Compared to other products approved to recognised standards (Jan 2015).  
†Subject to warranty statement.

rescueME PLB1 the world's smallest Personal Locator Beacon.\*

-  30% (typ) smaller
-  7 year battery life
-  7 year warranty†
-  66 channels GPS  
– Fast accurate positioning
-  No subscription
-  Waterproof to 15m
-  Easily deployed antenna
-  Flotation pouch included\*\*

In an emergency rescueME PLB1 provides 3 methods of communicating your location, ensuring maximum chance of survival.

-  406 MHz  
Link via satellite to Emergency Services
-  121.5 MHz  
Homing Beacon to aid location by Search & Rescue
-  High intensity strobe

The PLB1 is not designed and intended for operation while immersed in water. During operation the beacon must always be kept above the water.  
†Subject to warranty statement.

Actual size



The ultra-compact rescueME PLB1 can be easily fitted into your life-jacket or onto a belt, taking up minimal space and ensuring it is readily accessible.

Antenna deployment could not be easier, with a gentle pull the aerial is released.

rescueME PLB1 can be operated with a single hand in even the most challenging situations. A simple spring loaded flap covers the activation button preventing inadvertent use.

The integrated ultra-bright strobe light ensures maximum visibility.

Whatever your adventure, whether at sea or on land, the rescueME PLB1 provides the reassurance that emergency services can be alerted by the press of a button.

rescueME PLB1 works with the only officially recognised worldwide dedicated search and rescue satellite network (operated by Cospas Sarsat). As this is funded by governments there are no charges to use this service.

When activated, the rescueME PLB1 transmits your position and your unique ID to a Rescue Coordination Centre via satellite link. The relevant rescue services are promptly notified of your emergency and regularly advised of your current location (see diagram).

To assist with search and rescue, a homing signal is transmitted on 121.5MHz. This is received by equipment fitted to both sea and airborne rescue craft.



One handed operation



Moulded lens enhances light output



Unique cradle mounting system



Easy deploy retractable antenna

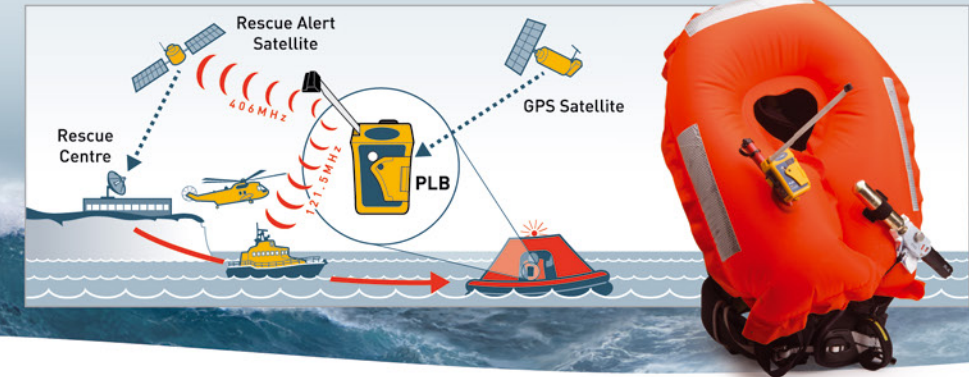



rescueME MOB1 the world's smallest AIS Man Over Board personal locator device.\*



**AIS**  
(Automatic Identification System)



**Integrated DSC transmitter\*\***  
(digital selective calling)



30% (typ) smaller



Automatic activation



Simple lifejacket integration



7 year battery life



24+ hours operational life



5 year warranty†



66 channel GPS  
- Fast accurate positioning

In an emergency rescueME MOB1 provides 2 methods of rapidly communicating your location back to the vessel, plus providing visual indication.



**AIS** Provides accurate positional information on the vessel's chart plotter plus the distance and bearing of the person(s) in the water



**DSC**  
Activates the alarm on a DSC enabled VHF radio



**High intensity strobe**

\*Compared to other products approved to recognised standards and available (Jan 2015).  
\*\*DSC functionality is subject to regulations of country.  
†Subject to warranty statement.



rescueME MOB1 is intended to be installed within the life-jacket and will activate automatically on inflation, sending the first alert within 15 seconds.

The integrated strobe light ensures maximum visibility in low light conditions.

rescueME MOB1 is compatible with even the most compact inflatable life-jackets.



The best chance of rapid rescue if you fall overboard comes from your own vessel. Your crew needs to be immediately aware of the incident and keep track of your position whilst recovery is carried out. Even in the most moderate of seas it is alarming how quickly a visual sighting of a man overboard can be lost.

Once activated your MOB1 will transmit an alert to all AIS receivers and AIS enabled plotters in the vicinity. The integrated GPS ensures precise location is sent to your vessel and any others that may be assisting (see diagram).

An additional feature of the MOB1 is its ability to activate the DSC alarm on your vessels VHF, alerting your crew to the situation.

**Compatibility:** Most modern AIS plotters and DSC VHF comply with the standards required to receive the MOB transmissions. It is recommended that you check compatibility with the equipment manufacturer, particularly if you are using older equipment.



Pull down to arm



Activation tape



Life-jacket mount

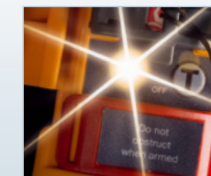

Integrated strobe light

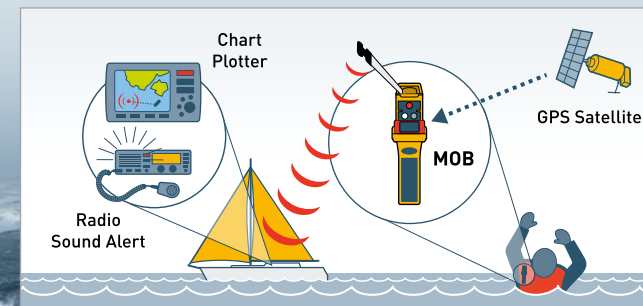

rescueME EDF1 the world's most compact Electronic Distress Flare.\*



Advanced LED technology  
safe operation



Compact, lightweight, rugged



Superb 360 degree visibility  
(Azimuth)



40% (typ) smaller



Excellent visibility  
for SAR aircraft and helicopters



Constant brightness  
maintained throughout the life of the battery



4 modes of operation  
plus SOS signalling



User replaceable battery



Visibility range up to 7 miles



Up to 6 hours operation



Waterproof to 10 meters



Battery test function



The **rescueME EDF1** electronic distress flare offers users a safe and long-lasting solution to visual signalling in an emergency.

The unique lens design combined with the use of advanced LEDs and highly efficient circuit technology ensures a constant level of light output throughout the life of the user replaceable battery.

The light output is a beam of over 30° throughout the full 360° azimuth, providing in excess of 6 times more light coverage than other electronic flares\*. Light is also distributed throughout the hemisphere above the unit to ensure visibility from the air.

Unlike single use pyrotechnic flares the **rescueME EDF1** can be used repeatedly in any of its four modes, ensuring continued visibility is maintained over a longer period. The unit is both safe to store and operate while also eliminating any worries associated with disposal.

The compact size and rugged design means the **rescueME EDF1** is the perfect safety product for a grab bag, life raft or hiker's backpack.



Pull down protective cover to access operation keys



One handed operation



360 degree visibility

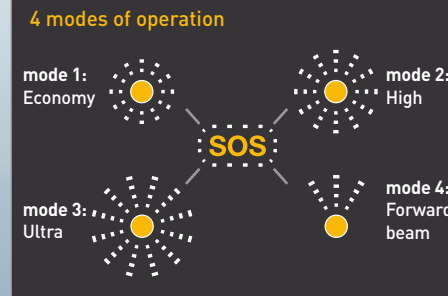

\*Compared to other hand held electronic flares for marine use (January 2015).



## rescueME PLB1 and EDF1, designed for mariners, aviators and those on land.

These compact, lightweight, and rugged designs make **rescueME** safety devices an essential companion for anyone who enjoys the outdoor life and who takes their personal safety and the safety of others seriously.



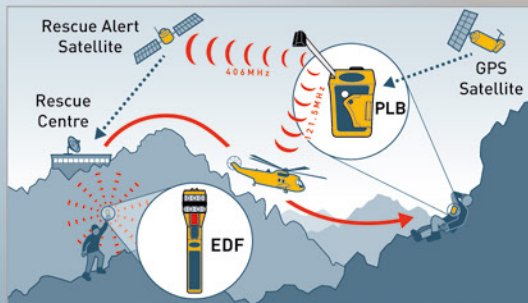









The dedicated satellite network used when a PLB is activated covers the entire globe, from the Arctic to the Antarctic. No matter where you are on the planet, you are always able to alert the rescue services. Visual signalling is further enhanced by using the **rescueME EDF1** - a dedicated visual alerting device providing expansive light output throughout 360°, to ensure anyone in your vicinity is alerted to your position.



### rescueME PLB1

-  30% (typ) smaller
-  7 year battery life
-  7 year warranty
-  66 channel GPS  
- Fast accurate positioning
-  No subscription
-  Waterproof to 15m
-  Easily deployed antenna

### rescueME EDF1

-  Advanced LED technology  
safe operation
-  Compact, lightweight, rugged
-  Superb 360 degree visibility  
(Azimuth)
-  40% (typ) smaller
-  Excellent visibility  
for SAR aircraft and helicopters
-  Constant brightness  
maintained throughout the life of the battery
-  4+SOS 4 modes of operation  
plus SOS signalling
-  User replaceable battery
-  7 MILES Visibility range up to 7 miles
-  6 HRS Up to 6 hours operation
-  10m Waterproof to 10 meters
-  Battery test function



**PLB1 specifications**

Satellite transmission 406.040MHz, 5Watts  
 Homing transmission 121.5MHz, 50mW nominal  
 Operation life >24hrs at -20°C (-4°F)  
 Operating temperature range -20°C to +55°C (-4°F to +131°F)  
 Weight 116g (4.1oz)  
 Standards Cospas Sarsat T.001/T.007, ETSI EN302 152, RTCM SC11010, NSS-PLB11, IC RSS287

**PLB1 dimensions**

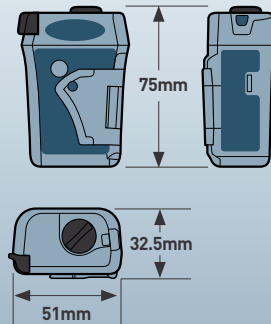

**EPIRB1 specifications**

Satellite transmission 406.040MHz, 12Watts\*  
 Homing transmission 121.5MHz, 50mW nominal  
 Operation life >48hrs at -20°C (-4°F)  
 Operating temperature range -20°C to +55°C (-4°F to +131°F)  
 Weight 422g (14.9oz)  
 Standards: Cospas Sarsat T.001/T.007, IEC61097-2, RTCM SC11000, IC RSS287

\*Max EIRP

**EPIRB1 dimensions**

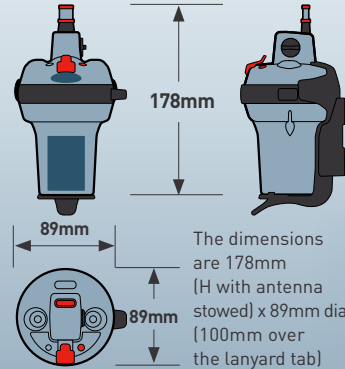

**MOB1 specifications**

AIS transmission transmit power (EIRP) 1Watt  
 Frequency 161.975/162.025MHz  
 DSC transmission transmit power (EIRP) 0.5Watt  
 Frequency 156.525MHz  
 Messages\* Individual distress relay distress alert (by single call made on press of the activation button)  
 Environmental Operating temperature range -20°C to +55°C  
 Storage temperature range -30°C to +70°C  
 Waterproof 10m depth  
 Weight 92 g (3.2oz)  
 Standards RTCM SC11901, EN303 098-1

\*DSC messages sent depend upon national regulations

**MOB1 dimensions**

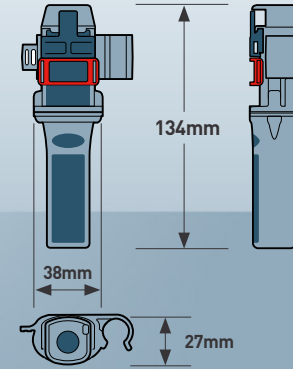

**EDF1 specifications**

Battery Type Lithium primary  
 Chemistry Manganese dioxide (LiMnO2)  
 Operating life >6hours  
 Environmental Operating temperature range -20°C to +55°C  
 Storage temperature range -30°C to +70°C  
 Waterproof 10metres at +20°C  
 Weight 155g (5.5oz)

**EDF1 dimensions**

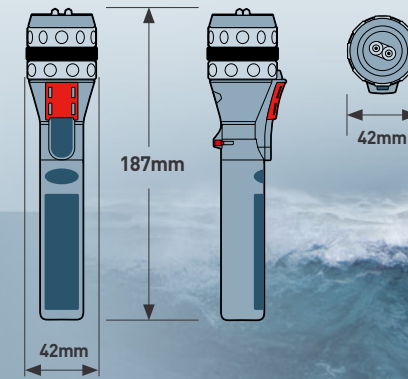

Product	Battery life hr's Typ +/-	Crewed			Short Handed			Land	Air
		Inshore	Coastal	Offshore	Inshore	Coastal	Offshore		
<b>rescueME)</b>									
rescueME EPIRB1	48	✓	✓		✓	✓			
rescueME PLB1	24			✓			✓	✓	
rescueME MOB1	24	✓	✓	✓	✓	✓	✓		
rescueME EDF1	6	✓	✓	✓	✓	✓	✓	✓	✓
<b>SAFE SEA)</b>									
SafeSea E100G	96			✓			✓		
SafeSea SART	12-96			✓			✓		
SafeSea VHF	16	✓	✓	✓	✓	✓	✓		

Rapid rescue diminishes the chance of fatality due to hypothermia. Always buy the best safety equipment available to you. For more information on both the rescueME and SafeSea ranges please visit [OceanSignal.com](http://OceanSignal.com)